

CU Series ø10, ø16, ø20, ø25, ø32

Construction

With auto switch

ø10

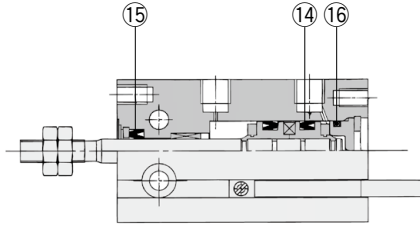
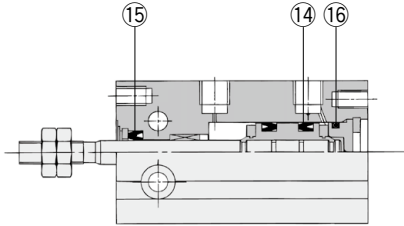

ø16 to ø32

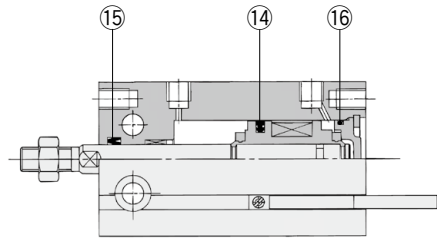
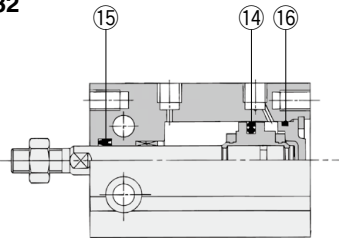

* The numbers correspond with those in the "Construction" of the CU series in the Best Pneumatics catalog.

Seal Kit List

No.	Description	Material	Note
14	Piston seal	NBR	
15	Rod seal		
16	Gasket		

Replacement Parts: Seal Kit

Bore size (mm)	Part no.	Contents
10	CU10D-PS	Set of nos. 14, 15, 16
16	CU16D-PS	
20	CU20D-PS	
25	CU25D-PS	
32	CU32D-PS	

* ø6 cannot be repaired.

* The seal kit includes 14, 15, 16. Order the seal kit based on each bore size.

* The seal kit includes a grease pack (10 g).

Order with the following part number when only the grease pack is required.

Grease pack part no.: GR-S-010 (10 g)

CU Series ø10, ø16, ø20, ø25, ø32

Construction

Single acting, spring return

ø10

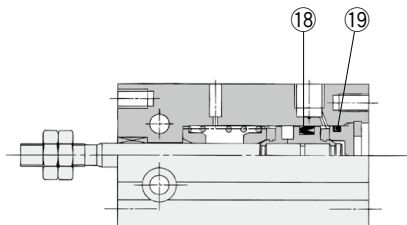

ø16 to ø32

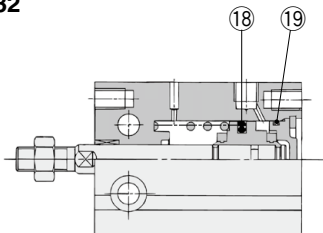

With auto switch

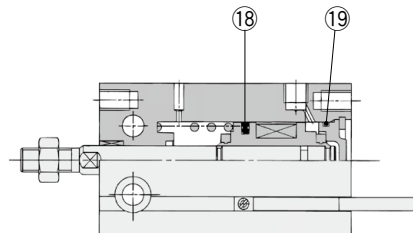
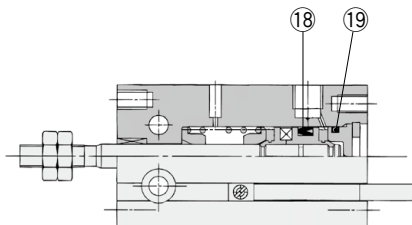

* The numbers correspond with those in the "Construction" of the CU series in the Best Pneumatics catalog.

Seal Kit List

No.	Description	Material	Note
18	Piston seal	NBR	
19	Gasket		

Replacement Parts: Seal Kit

Bore size (mm)	Part no.	Contents
10	CU10S-PS	Set of nos. 18, 19
16	CU16S-PS	
20	CU20S-PS	
25	CU25S-PS	
32	CU32S-PS	

- * ø6 cannot be repaired.
 - * The seal kit includes 18, 19. Order the seal kit based on each bore size.
 - * The seal kit includes a grease pack (10 g).
- Order with the following part number when only the grease pack is required.

Grease pack part no.: GR-S-010 (10 g)

CU Series

ø10, ø16, ø20, ø25, ø32

Construction

Single acting, spring extend

ø10

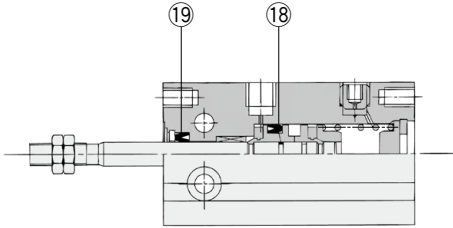

With auto switch

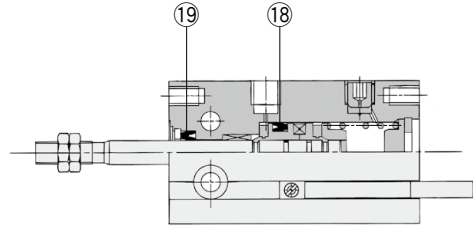

ø16 to ø32

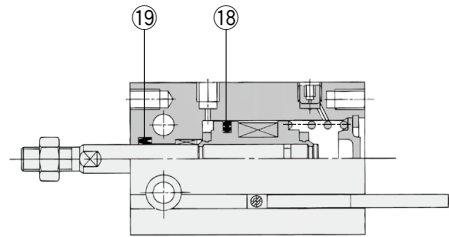
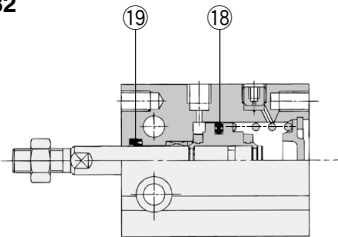

* The numbers correspond with those in the "Construction" of the CU series in the Best Pneumatics catalog.

Seal Kit List

No.	Description	Material	Note
18	Piston seal	NBR	
19	Rod seal		

Replacement Parts: Seal Kit

Bore size (mm)	Part no.	Contents
10	CU10T-PS	Set of nos. 18, 19
16	CU16T-PS	
20	CU20T-PS	
25	CU25T-PS	
32	CU32T-PS	

* ø6 cannot be repaired.

* The seal kit includes 18, 19. Order the seal kit based on each bore size.

* The seal kit includes a grease pack (10 g).

Order with the following part number when only the grease pack is required.

Grease pack part no.: GR-S-010 (10 g)

Actuators

Modular F.R.L.
Pressure Control Equipment

Air Preparation
Equipment

Industrial Filters

Replacement
Procedure

Actuators

Modular F.R.L.
Pressure Control Equipment

Industrial Filters

CU/CUX Series ø10, ø16, ø20, ø25, ø32

Construction

With auto switch

ø10

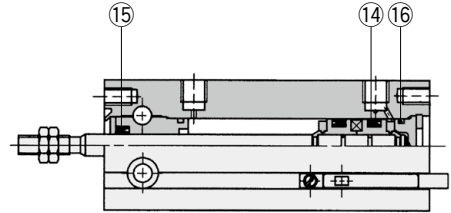
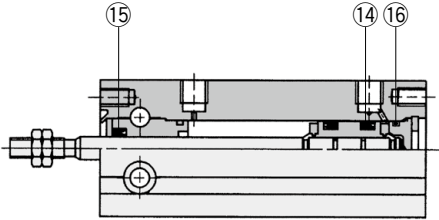

ø16 to ø32

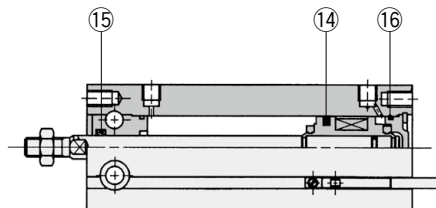
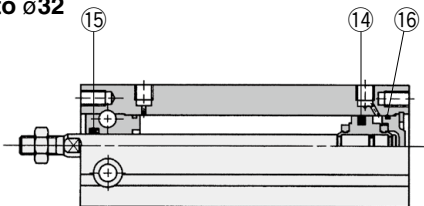

- * The construction of the low speed cylinder CUX series is the same as the CU series.
- * The numbers correspond with those in the "Construction" of the CU series in the Best Pneumatics catalog.

Seal Kit List

No.	Description	Material	Note
14	Piston seal	NBR	
15	Rod seal		
16	Gasket		

Replacement Parts: Seal Kit

Bore size (mm)	Part no.	Contents
Long stroke type		
10	CU10D-PS	Set of nos. 14, 15, 16
16	CU16D-PS	
20	CU20D-PS	
25	CU25D-PS	
32	CU32D-PS	
Low speed cylinder		
16	CUX16-PS	Set of nos. 14, 15, 16
20	CUX20-PS	
25	CUX25-PS	
32	CUX32-PS	

- * ø6 cannot be repaired.
- * The seal kit for the long stroke type and low speed cylinders includes 14, 15, and 16. Order the seal kit based on each bore size.
- * The seal kit includes a grease pack (10 g).
Order with one of the following part numbers when only the grease pack is required.
- Long stroke type
Grease pack part no.: GR-S-010 (10 g)
- Low speed cylinder
Grease pack part no.: GR-L-005 (5 g)
GR-L-010 (10 g)
GR-L-150 (150 g)

CU Series ø20, ø25, ø32

Construction

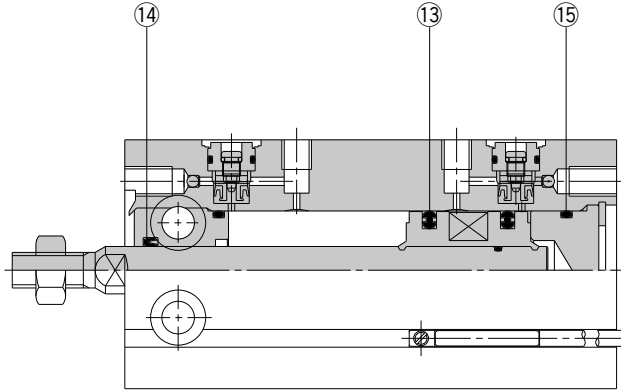

* The numbers correspond with those in the "Construction" of the CU series in the Best Pneumatics catalog.

Seal Kit List

No.	Description	Material	No. of pcs.	Note
13	Piston seal	NBR	2	
14	Rod seal		1	
15	Gasket		1	

Replacement Parts: Seal Kit

Bore size (mm)	Part no.	Contents
ø20	CU20A-PS	Set of nos. 13, 14, 15
ø25	CU25A-PS	
ø32	CU32A-PS	

* The seal kit includes 13, 14, 15. Order the seal kit based on each bore size.

* The seal kit includes a grease pack (10 g).

Order with the following part number when only the grease pack is required.

Grease pack part no.: GR-S-010 (10 g)