

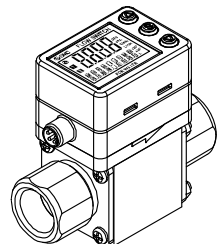

ORIGINAL INSTRUCTIONS

**Instruction Manual**  
**Digital Flow Switch – IO-Link compatible**  
**PF3W7##-L series**

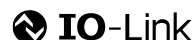

The intended use of the digital flow switch is to monitor and display flow information while connected to the IO-Link communication protocol.

**1 Safety Instructions**

These safety instructions are intended to prevent hazardous situations and/or equipment damage. These instructions indicate the level of potential hazard with the labels of “Caution,” “Warning” or “Danger.” They are all important notes for safety and must be followed in addition to International Standards (ISO/IEC) <sup>(1)</sup>, and other safety regulations.

<sup>(1)</sup> ISO 4414: Pneumatic fluid power - General rules relating to systems.  
 ISO 4413: Hydraulic fluid power - General rules relating to systems.  
 IEC 60204-1: Safety of machinery - Electrical equipment of machines. (Part 1: General requirements)  
 ISO 10218-1: Manipulating industrial robots -Safety. etc.

- Refer to product catalogue, Operation Manual and Handling Precautions for SMC Products for additional information.
- Keep this manual in a safe place for future reference.

<b>Caution</b>	Caution indicates a hazard with a low level of risk which, if not avoided, could result in minor or moderate injury.
<b>Warning</b>	Warning indicates a hazard with a medium level of risk which, if not avoided, could result in death or serious injury.
<b>Danger</b>	Danger indicates a hazard with a high level of risk which, if not avoided, will result in death or serious injury.

**Warning**

- **Always ensure compliance with relevant safety laws and standards.**
- All work must be carried out in a safe manner by a qualified person in compliance with applicable national regulations.
- This product is class A equipment intended for use in an industrial environment. There may be potential difficulties in ensuring electromagnetic compatibility in other environments due to conducted or radiated disturbances.
- Refer to the operation manual on the SMC website (URL: <https://www.smcworld.com>) for more safety instructions.

**2 Specifications**

Model	PF3W 704	PF3W 720	PF3W 740	PF3W 711	PF3W 721
Applicable fluid	Water and ethylene glycol solution with a viscosity of 3 mPa·s (3 cP) or less				
Detection method	Karman vortex				
Rated flow range	0.5 to 4 L/min	2 to 16 L/min	5 to 40 L/min	10 to 100 L/min	50 to 250 L/min
Display flow range	0.35 to 5.50 L/min	1.7 to 22.0 L/min	3.5 to 55.0 L/min	7 to 140 L/min	20 to 350 L/min
Switch point range	0.35 to 5.50 L/min	1.7 to 22.0 L/min	3.5 to 55.0 L/min	7 to 140 L/min	20 to 350 L/min
Min. setting unit	0.01 L/min	0.1 L/min		1 L/min	
Conversion of accumulated pulse (Pulse width = 50 ms)	0.05 L/pulse	0.1 L/pulse	0.5 L/pulse	1 L/pulse	
Fluid temperature	0 to 90 °C				0 to 70 °C
	(No freezing and condensation)				
Display unit	L/min for real-time flow and L for accumulated flow				
Accuracy	±3%F.S.				
Repeatability	±2%F.S.				
Temperature characteristics	±5%F.S. max. (25 °C reference)				
Operating pressure range	Refer to graph of operating pressure and proof pressure				
Proof pressure	Refer to graph of operating pressure and proof pressure				
Pressure loss	Refer to graph of pressure loss				
Accumulated flow range	999,999,999.9 L		9,999,999,999 L		
	By 0.1 L		By 1 L		
Switch output	Select from NPN or PNP open collector output				
Max. load current	80 mA				
Max. applied voltage	30 V (during NPN output)				
Internal voltage drop	1.5 V or less (Load current 80 mA)				
Delay time	3.5 ms or less Variable at 0 to 60 s / 0.01 step				
Hysteresis mode	Hysteresis mode	Variable from 0			
	Window comparator mode				
Output protection	Short circuit protection				
Output mode	Flow	Selects one of output (hysteresis or window comparator mode), output for the accumulated flow, the accumulated pulse output, error output and switch OFF.			
	Temp.	Selects the output for fluid temperature (hysteresis mode or window comparator mode).			

**2 Specifications (continued)**

Model	PF3W 704	PF3W 720	PF3W 740	PF3W 711	PF3W 721
Display method	2-screen display (main screen, sub screen) Main screen: 4-digit, 7-segment, 2-colour; red/green Sub screen: 9-digit, 11-segment (5 <sup>th</sup> digit is 7-segment only), White Display update frequency 5 times/sec.				
Indicator light	Output 1 and 2: Orange				
Supply voltage	Used as switch output device 12 to 24 VDC, including ripple (p-p) 10%				
	Used as IO-Link device 18 to 30 VDC, including ripple (p-p) 10%				
Current consumption	50 mA max.				
Digital filter	Select from 0.5 s/1.0 s/2.0 s/5.0 s/10.0 s/15.0 s/20.0 s/30.0 s				
Environment	Enclosure	IP65			
	Operating temp. range	0 to 50 °C (No freezing and condensation)			
	Operating humidity range	Operation, Storage: 35 to 85%R.H. (No condensation)			
	Withstand voltage	1000 VAC, for 1 minute between terminals and housing			
Material of fluid contact parts	PPS, SUS304, FKM, SCS13				PPS, SUS304 FKM
	Grease free				
Piping port size	3/8	3/8, 1/2	1/2, 3/4	3/4, 1	1 1/4, 1 1/2

**2.1 IO-Link specifications**

IO-Link type	Device	
IO-Link version	V1.1	
Communication speed	COM2 (38.4 kbps)	
Min. cycle time	3.5 ms	
Process data length	Input Data: 6 bytes, Output Data: 0 byte	
On request data communication	Available	
Data storage function	Available	
Event function	Available	
Vendor ID	131 (0x0083)	
Device ID	PF3W704*-**-L**	0X0160 (352)
	PF3W720*-**-L**	0X0161 (353)
	PF3W740*-**-L**	0X0162 (354)
	PF3W711*-**-L**	0X0163 (355)
	PF3W721*-**-L**	0X0164 (356)
	PF3W704*-**-L*T**	0X0165 (357)
	PF3W720*-**-L*T**	0X0166 (358)
	PF3W740*-**-L*T**	0X0167 (359)
PF3W711*-**-L*T**	0X0168 (360)	
PF3W721*-**-L*T**	0X0169 (361)	
IODD file	SMC-PF3W7**-*L*(T)-*****-yyyymmdd-IODD1.1	

- The IODD configuration file can be downloaded from the SMC website (URL: <https://www.smcworld.com>) for more specification details.

**Warning**

- Special products (-X) might have specifications different from those shown in this section. Contact SMC for specific drawings.

**3 Names of Individual parts**

**3.1 PF3W7##-L (with flow adjustment valve)**

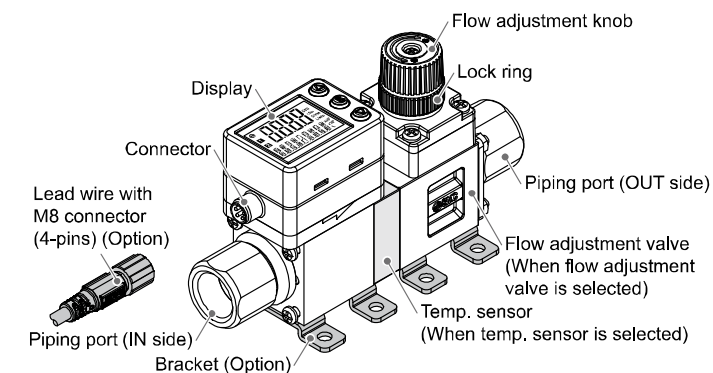

Element	Description
Connector	Connector for electrical connections.
Lead wire with M8 connector	Lead wire to supply power and transmit output signals.
Piping port	Port to connect the fluid inlet at IN and fluid outlet at OUT.
Bracket	Bracket for mounting the product.
Temperature sensor	Sensor for detecting the fluid temperature.
Flow adjustment valve	Restricting valve to adjust the flow rate.
Flow adjustment knob	Knob for adjusting the flow rate.
Lock ring	Ring for locking the flow adjustment valve.
Display	Displays the flow, settings and error codes (See below).

**3.2 Display**

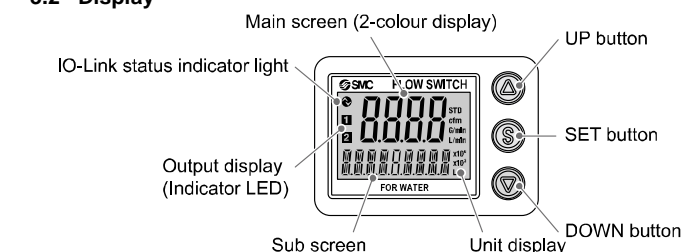

Element	Description
Main screen (2-colour display)	Displays the flow, the status of setting mode and error code.
Sub screen	Displays the accumulated flow, set value, peak/bottom value, fluid temperature and line names.
Output display (Indicator LED)	Displays the output status of OUT1 and OUT2. When ON: Orange LED is ON.
Unit display	Displays the unit selected.
UP button	Selects a mode and the display shown at the sub screen, and increases the ON/OFF set values.
SET button	Press this button to select mode and to confirm a set value.
DOWN button	Selects a mode and the display shown at the sub screen, and decreases the ON/OFF set values.
IO-Link status indicator light	LED is ON when OUT1 is used in IO-Link mode. (LED is OFF in SIO mode)

- Refer to the operation manual on the SMC website (URL: <https://www.smcworld.com>) for more details of IO-Link indicator light operation and display.

## 4 Installation

### 4.1 Installation

#### Warning

- Do not install the product unless the safety instructions have been read and understood.
- Use the product within the specified operating pressure and temperature range.
- Proof pressure could vary according to the fluid temperature. Check the characteristics data for operating pressure and proof pressure.

### 4.2 Environment

#### Warning

- Do not use in an environment where corrosive gases, chemicals, salt water or steam are present.
- Do not use in an explosive atmosphere.
- Do not expose to direct sunlight. Use a suitable protective cover.
- Do not install in a location subject to vibration or impact in excess of the product's specifications.
- Do not mount in a location exposed to radiant heat that would result in temperatures in excess of the product's specifications.

### 4.3 Mounting

- Never mount the product in a location where it will be used as a support.
- Mount the product so that the fluid flows in the direction indicated by the arrow on the side of the body.
- Check the flow characteristics data for pressure loss and the straight inlet pipe length effect on accuracy, to determine inlet piping requirements.
- Do not sharply reduce the piping size.
- The monitor with integrated display can be rotated. It can be set at 90° intervals clock and anticlockwise, and also at 45° and 225° clockwise. Rotating the display with excessive force will damage the end stop.

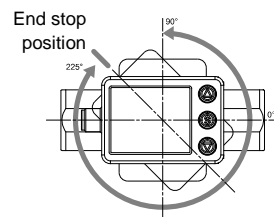

#### Bracket mounting (PF3W704 / 720 / 740)

Mount the product (with bracket) using the mounting screws supplied (M4 x 4 pcs).

For models with flow adjustment valve attached, fix using 8 mounting screws. Bracket thickness is approx. 1.5 mm.

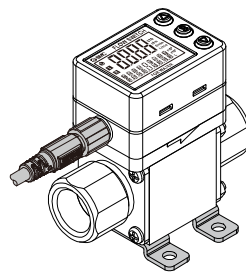

#### Bracket mounting (PF3W711)

Mount the product (with bracket) using the mounting screws supplied (M5 x 4 pcs).

Bracket thickness is approx. 2 mm.

#### Direct mounting (PF3W704 / 720 / 740)

Mount using self tapping screws (nominal size: 3.0 x 4 pcs).

For models with flow adjustment valve attached, mount using 8 self tapping screws. Tightening torque must be 0.5 to 0.7 N·m.

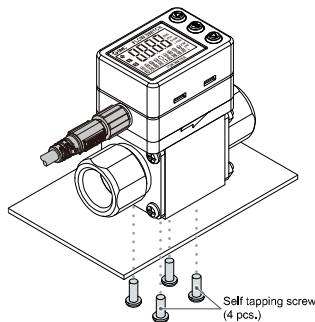

#### Direct mounting (PF3W711)

Mount using self tapping screws (nominal size: 4.0 x 4 pcs).

Tightening torque must be 1.0 to 1.2 N·m.

Self tapping screws should not be re-used.

Refer to the operation manual on the SMC website (URL: <https://www.smcworld.com>) for mounting hole details and outline dimensions.

## 4 Installation (continued)

### 4.4 Piping

#### Caution

- Before connecting piping make sure to clean up chips, cutting oil, dust etc.
- When installing piping or fittings, ensure sealant material does not enter inside the port.
- Ensure there is no leakage after piping.
- When connecting piping to the product, a spanner should be used on the metal piping attachment only.

Using a spanner on other parts may damage the product.

In particular, do not let the spanner come into contact with the M8 connector. The connector can be easily damaged.

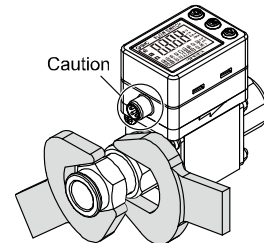

Width across flats of attachment

3/8	20.9 mm
1/2	23.9 mm
3/4	29.9 mm
1	41 mm

After hand tightening, apply a spanner of the correct size to the spanner flats on the product, and tighten it for 2 to 3 rotations, to the tightening torque shown in the table below.

Nominal thread size	Tightening torque
Rc(NPT)3/8	15 to 20 N·m
Rc(NPT)1/2	20 to 25 N·m
Rc(NPT)3/4	28 to 30 N·m
Rc(NPT)1	36 to 38 N·m
Rc(NPT)1 1/4	40 to 42 N·m
Rc(NPT)1 1/2	48 to 50 N·m

If the tightening torque is exceeded, the product can be damaged. If the correct tightening torque is not applied, the fittings may become loose.

### 4.5 Wiring

#### Caution

- Do not perform wiring while the power is on.
- Confirm proper insulation of wiring.
- Do not route wires and cables together with power or high voltage cables. Otherwise the product can malfunction due to interference of noise and surge voltage from power and high voltage cables to the signal line. Route the wires (piping) of the product separately from power or high voltage cables.
- Keep wiring as short as possible to prevent interference from electromagnetic noise and surge voltage. Do not use a cable longer than 20 m.
- Ensure that the FG terminal is connected to ground when using a commercially available switch-mode power supply.

#### When used as switch output device

No.	Name	Wire colour	Function
1	DC(+)	Brown	12 to 24 VDC
2	N.C./OUT2	White	Not connected / Switch output 2 (SIO)
3	DC(-)	Blue	0 V
4	OUT1	Black	Switch output 1

#### When used as IO-Link device

No.	Name	Wire colour	Function
1	L+	Brown	18 to 30 VDC
2	N.C./OUT2	White	Not connected / Switch output 2 (SIO)
3	L-	Blue	0 V
4	C/Q	Black	IO-Link data / Switch output 1 (SIO)

\*: Wire colours are for lead wire included with the PF3W7 series.

## 5 Flow Setting

### 5.1 Measurement mode

The mode in which the flow is detected and displayed, and the switch function is operating.

This is the basic operating mode; other modes should be selected for set-point and other function setting changes.

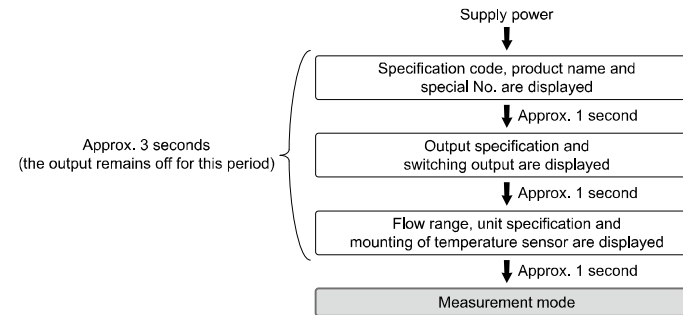

### 5.2 Switch operation

When the flow exceeds the set value, the switch will be turned ON.

When the flow falls below the set value by the amount of hysteresis or more, the switch will be turned OFF.

If the operation shown below is acceptable, keep this setting.

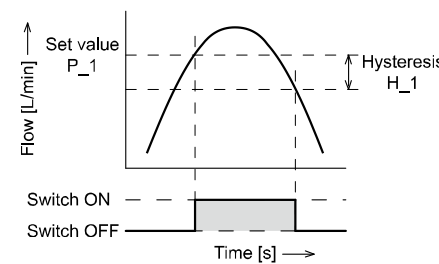

## 6 3-step Setting mode

- Press the SET button in measurement mode to display set values. (The item to be changed is displayed on the sub display) Set value on the right side of the sub screen flashes.

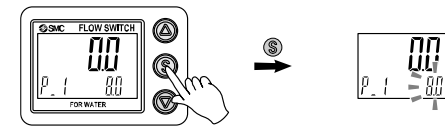

- Press the UP or DOWN button to change the set value. The UP button is to increase and the DOWN button is to decrease.

- Press the UP button once to increase by one digit, or press and hold to continuously increase.

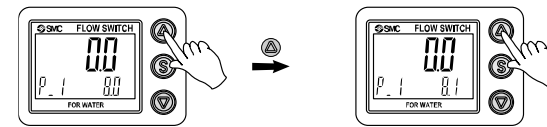

- Press the DOWN button once to decrease by one digit, or press and hold to continuously decrease.

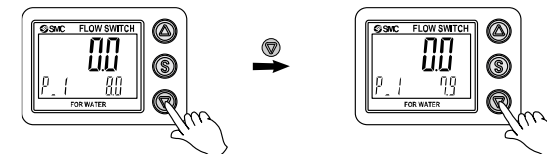

- Press the SET button to finish the setting.

- For setting of hysteresis, perform the settings referring to [F 1] Setting of OUT1.
- Note that the set value and hysteresis are limited by each other.
- For more detailed settings, set each function in Function selection mode.

## 7 Function Setting

### 7.1 Function selection mode

In measurement mode, press the SET button for 3 to 5 seconds to display [F□□] on the main screen.

Select to display the function to be change [F□□].

Press and hold the SET button for 2 seconds or longer in function selection mode to return to measurement mode.

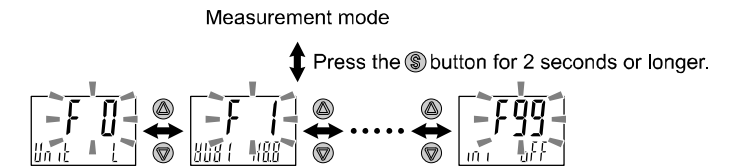

The function number is increased and decreased by the UP and DOWN buttons. Display the required function number and press the SET button.

### 7.2 Sub screen display

In measurement mode, the sub screen display can be temporarily changed by pressing the UP or DOWN buttons.

After 30 seconds, it will automatically reset to the display selected in [F10]. Example shown is for the 16 L/min type.

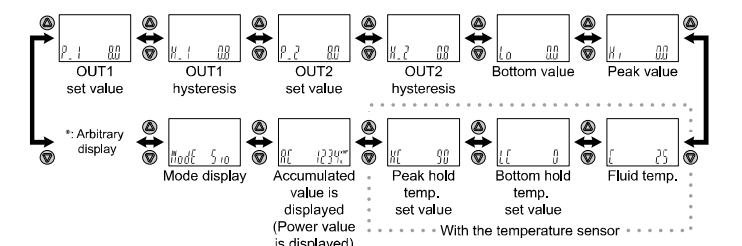

### 7.3 Default Function settings

	Item	Default setting
[F 0]	[ Unit] Display units	[ L] L/min, °C
	[ NorP] Switch output NPN/PNP	[ PnP] PNP output
[F 1]	[ oUt1] Output mode (OUT1)	[ HYS] Hysteresis mode
	[ 1ot] Switch operation (OUT1)	[ 1_P] Normal output
	[ P_1] Set value (OUT1)	50% of maximum rated flow
	[ H_1] Hysteresis (OUT1)	5% of maximum rated flow
	[ dtH1] Delay time at ON	[ 0.00] 0.00 s
	[ dtL1] Delay time at OFF	[ 0.00] 0.00 s
[F 2]	[ CoL] Display colour (OUT1)	[ 1SoG] ON: Green OFF: Red (OUT1)
	[ oUt2] Output mode (OUT2)	[ HYS] Hysteresis mode
	[ 2ot] Switch operation (OUT2)	[ 2_P] Normal output
	[ P_2] Set value (OUT2)	50% of maximum rated flow
	[ H_2] Hysteresis (OUT2)	5% of maximum rated flow
	[ dtH2] Delay time at ON	[ 0.00] 0.00 s
[F 2]	[ dtL2] Delay time at OFF	[ 0.00] 0.00 s
	[ CoL] Display colour (OUT2)	[ 1SoG] ON: Green OFF: Red (OUT2)
	[ oUt2] Output mode (OUT2)	[ tHYS] Temperature Hysteresis
	[ 2ot] Switch operation (OUT2)	[ 2_n] Reverse output
	[ tn_2] Set value (OUT2)	50% of maximum rated temp.
	[ tH_2] Hysteresis (OUT2)	0% of maximum rated temp.
[F 2]	[ dtH2] Delay time at ON	[ 0.00] 0.00 s
	[ dtL2] Delay time at OFF	[ 0.00] 0.00 s
	[ CoL] Display colour (OUT2)	[ 1SoG] ON: Green OFF: Red (OUT2)

## 7 Function Setting (continued)

Item		Default setting
[F 3]	[ FIL] Digital filter setting	[ 1.0] 1.0 s
[F10]	[ SUB] Sub screen display setting	[ dEF] Standard (OUT1 set value displayed) *: When a temperature sensor is not connected.
		[ dEF] Standard (fluid temp. displayed) *: When a temperature sensor is connected.
[F30]	[ SAvE] Accumulated flow value storage	[ oFF] Not saved
[F80]	[ diSP] Display OFF mode	[ on] Normal display
[F81]	[ Pin] Security code setting	[ oFF] OFF
[F90]	[ ALL] Setting of all functions	[ oFF] OFF
[F98]	[ tES] OUT1 output test mode	[ n] Normal output
[F99]	[ ini] Reset to the default settings	[ oFF] OFF

## 8 Other Settings

- Snap shot function
- Key-lock function

Refer to the operation manual on the SMC website (URL: <https://www.smcworld.com>) for setting these functions.

## 9 How to Order















Refer to the operation manual or catalogue on the SMC website (URL: <https://www.smcworld.com>) for How to order information.

## 10 Outline Dimensions (mm)

Refer to the operation manual or catalogue on the SMC website (URL: <https://www.smcworld.com>) for Outline Dimensions.

## 11 Troubleshooting

### 11.1 Error indication

Error	Error displayed	Description	Measures
OUT1 over current error		A load current applied to the switch output has exceeded the max. value (OUT1).	Turn the power off and remove the cause of the over current. Then turn the power on again.
OUT2 over current error		A load current applied to the switch output has exceeded the max. value (OUT2).	Turn the power off and remove the cause of the over current. Then turn the power on again.
Excessive instantaneous flow		The applied flow rate is above approx. 140% of maximum rated flow.	Reset applied flow to a level within the display range.
Excessive accumulated flow		The accumulated flow range is exceeded. (The decimal point position changes depending on the flow range.)	Reset the accumulated flow once. (Press the SET and DOWN button for 1 second or longer.)
Temp. upper limit exceeded		The fluid temperature is above 110 °C.	Reduce the fluid temperature.
Temp. lower limit exceeded		The fluid temperature is below -10 °C.	Rise the fluid temperature.
System error	     	Displayed if an internal data error has occurred.	Turn the power off and turn it on again. If the failure cannot be solved, contact SMC for repair.
Temp. sensor failure		The temperature sensor is damaged.	
Version does not match		Version of master and IO-Link does not match. Mismatch because master version is 1.0.	Align the master IO-Link version to the device.

If the error cannot be reset after the above measures are taken, or errors other than the above are displayed, please contact SMC.

Refer to the operation manual on the SMC website (URL: <https://www.smcworld.com>) for more detailed information about troubleshooting.

## 12 Maintenance

### 12.1 General Maintenance

#### Caution

- Not following proper maintenance procedures could cause the product to malfunction and lead to equipment damage.
- If handled improperly, compressed air can be dangerous.
- Maintenance of pneumatic systems should be performed only by qualified personnel.
- Before performing maintenance, turn off the power supply and be sure to cut off the supply pressure. Confirm that the air is released to atmosphere.
- After installation and maintenance, apply operating pressure and power to the equipment and perform appropriate functional and leakage tests to make sure the equipment is installed correctly.
- If any electrical connections are disturbed during maintenance, ensure they are reconnected correctly and safety checks are carried out as required to ensure continued compliance with applicable national regulations.
- Do not make any modification to the product.
- Do not disassemble the product, unless required by installation or maintenance instructions.

#### How to reset the product after a power cut or when the power has been unexpectedly removed

The settings of the product are retained from before the power cut or de-energizing.

The output condition also recovers to that before the power cut or de-energizing, but may change depending on the operating environment. Therefore, check the safety of the whole system before operating the product.

## 13 Limitations of Use

### 13.1 Limited warranty and Disclaimer/Compliance Requirements

Refer to Handling Precautions for SMC Products.

## 14 Product disposal

This product should not be disposed of as municipal waste. Check your local regulations and guidelines to dispose of this product correctly, in order to reduce the impact on human health and the environment.

## 15 Contacts

Refer to [www.smcworld.com](https://www.smcworld.com) or [www.smc.eu](https://www.smc.eu) for your local distributor / importer.

# SMC Corporation

URL: <https://www.smcworld.com> (Global) <https://www.smceu.com> (Europe)  
SMC Corporation, 4-14-1, Sotokanda, Chiyoda-ku, Tokyo 101-0021, Japan  
Specifications are subject to change without prior notice from the manufacturer.  
© 2021 SMC Corporation All Rights Reserved.  
Template DKP50047-F-085M