

Made to Order Common Specifications: -XC11: Dual Stroke Cylinder/Single Rod Type



23 Dual Stroke Cylinder/Single Rod Type

Two cylinders can be integrated by connecting them in line, and the cylinder stroke can be controlled in two stages in both directions.
Do not operate the CS1 series at twice the output.

Applicable Series

Series	Description	Model	Action	Note	Vol. no. (for std model)
CJ2	Air cylinder	CJ2-Z	Double acting, Single rod	Except with air cushion	②-1 From P. 46
	Air cylinder	CM2-Z	Double acting, Single rod		
CM2	Non-rotating rod	CM2K-Z	Double acting, Single rod	Except with air cushion	②-1 From P. 172
	Direct mount	CM2R-Z	Double acting, Single rod		
	Non-rotating rod, Direct mount type	CM2RK-Z	Double acting, Single rod		
CG1	Air cylinder	CG1-Z	Double acting, Single rod	Except with air cushion	②-1 From P. 292
	Non-rotating rod	CG1K-Z	Double acting, Single rod		
MB	Air cylinder	MB-Z	Double acting, Single rod	* Except ø125 and trunnion type	②-1 From P. 392
MB1	Air cylinder	MB1-Z	Double acting, Single rod	* Except ø125 and trunnion type	②-1 From P. 440
CA2	Air cylinder	CA2-Z	Double acting, Single rod	* Except trunnion type	②-1 From P. 470
	Non-rotating rod	CA2K	Double acting, Single rod	* Except trunnion type	
CS1	Air cylinder	CS1	Double acting, Single rod	* Except trunnion type	②-1 From P. 530
CS2	Air cylinder	CS2	Double acting, Single rod	* Except trunnion type	②-1 From P. 568
CQS	Compact cylinder	CQS	Double acting, Single rod	Except with bracket	②-1 From P. 693
CQ2	Compact cylinder	CQ2-Z	Double acting, Single rod	Except with bracket	Web Catalog
	Air-hydro cylinder	CQ2H-Z	Double acting, Single rod	Except with bracket	
CNA2	Cylinder with lock	CNA2	Double acting, Single rod	* Except trunnion type	②-2 From P. 922
MGG	Guide cylinder	MGG	Double acting		②-2 From P. 538
MGC	Guide cylinder	MGC	Double acting		②-2 From P. 578

How to Order

CJ2	Mounting type	Bore size	-	Stroke A	+	Stroke B-A	Z - XC11		
CM2	Mounting type	Bore size	-	Stroke A	+	Stroke B-A	Suffix Z - XC11		
CG1	Mounting type	Type	Bore size	-	Stroke A	+	Stroke B-A	Suffix Z - XC11	
MB MB1	Mounting type	Bore size	-	Stroke A	Suffix	+	Stroke B-A	Suffix Z - XC11	
* Except trunnion type									
CA2	Mounting type	Type	Bore size	-	Stroke A	Suffix	+	Stroke B-A	Suffix Z - XC11
* Except trunnion type									
CA2K	Mounting type	Type	Bore size	-	Stroke A	Suffix	+	Stroke B-A	Suffix - XC11
* Except trunnion type									
CS1	Mounting type	Tubing material	Bore size	-	Stroke A	Suffix	+	Stroke B-A	Suffix - XC11
* Except trunnion type									
CS2	Mounting type	Bore size	Port suffix	-	Stroke A	Suffix	+	Stroke B-A	Suffix - XC11
* Except trunnion type									
CQSB	Bore size	-	Stroke S ₁	+	Stroke S ₂ -S ₁	D(C)(M) - XC11			
CQ2B	Bore size	-	Stroke S ₁	+	Stroke S ₂ -S ₁	D(C)(M)(Z) - XC11			
CNA2	Mounting type	Type	Bore size	-	Stroke A	Suffix	+	Stroke B-A	Suffix - D - XC11
Dual stroke cylinder/Single rod ↓									

Specifications: Same as standard type (Please contact SMC for each manufacturable stroke length.)

Functional description of dual stroke cylinder

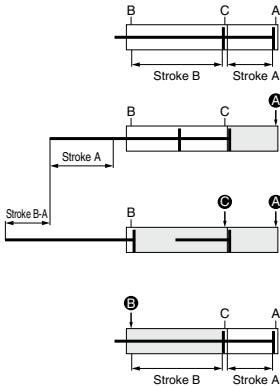

- 1) Initial state
(0 stroke position)
- 2) 1st stage Stroke A operation
When the air pressure is supplied from the A port, the rod operates the stroke A.
- 3) 2nd stage Stroke B-A operation
Following the 1st stage, when the air pressure is supplied from the C port, the rod operates the stroke B-A.
- 4) Cylinder retraction
When the air pressure is supplied from the B port, the rod retracts completely.



Precautions

⚠ Caution

1. Do not supply air until the cylinder is fixed with the attached bolt.
2. If air is supplied without securing the cylinder, the cylinder could lurch, posing the risk of bodily injury or damage to the peripheral equipment.

Stroke A or stroke B operation can be made individually.

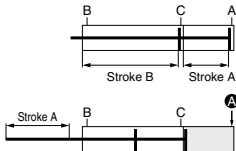

Stroke A operation

- 1) Initial state
(0 stroke position)
- 2) Operation
When the air pressure is supplied from the A port, the rod operates the stroke A.

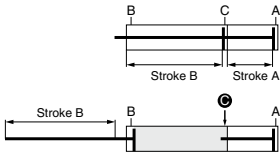

Stroke B operation

- 1) Initial state
(0 stroke position)
- 2) Operation
When the air pressure is supplied from the C port, the rod operates the stroke B.

Double output is possible.

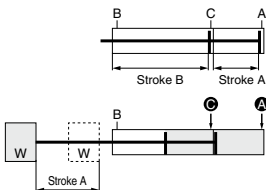

- 1) Initial state
(0 stroke position)
- 2) Double output
When the air pressure is supplied to the A and C ports at the same time, the double output can be obtained in the stroke A range.

Made to Order Common Specifications: -XC11: Dual Stroke Cylinder/Single Rod Type



23 Dual Stroke Cylinder/Single Rod Type

Dimensions (Dimensions other than below are the same as standard type.)

CJ2 series

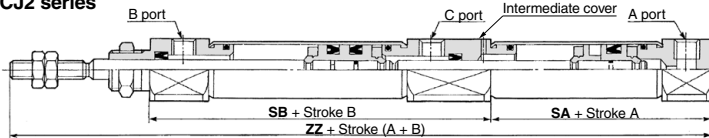

(mm)			
Bore size (mm)	SA	SB	Z
10	31	53.5	112.5
16	31.5	54.5	114

Note) When mounting an auto switch at the extended piston rod A side, the following auto switches interfere with the intermediate cover. In this case, please mount on the stroke B side. Please be aware that the auto switch defects and temporarily turns ON/OFF when passing the intermediate position of the B stroke.

Solid state auto switch : D-H7□, D-H7C, D-H7□W, D-H7NF, D-H7BA

Reed auto switch : D-C7□, D-C80, D-C73C, D-C80C, D-A80, D-A9□, D-A9□V, D-A79W, D-A73

CM2 series

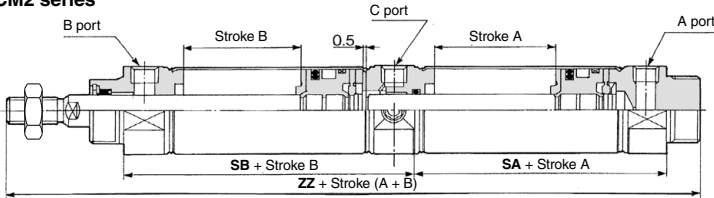

(mm)			
Bore size (mm)	SA	SB	ZZ
20	48	62	164
25	48	62	168
32	50	64	172
40	67.5	88.5	222

CM2R series

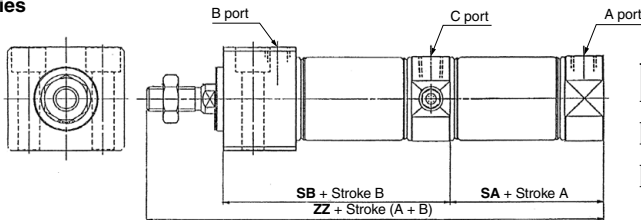

(mm)			
Bore size (mm)	SA	SB	ZZ
20	48	76	151
25	48	76	155
32	50	78	159
40	67.5	104.5	206

CG1 series

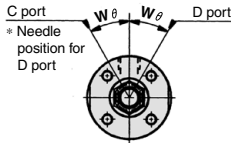
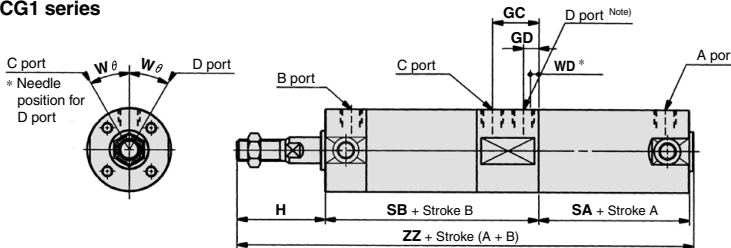

Note) D port type Type N: Rubber bumper, Plug with fixed orifice;

Type A: Air cushion, element non-installation (Release to atmospheric pressure)

CG1, CG1K

(mm)										
Bore size	GC	GD	H	SA	SB	Wθ	ZZ	Air cushion		Long stroke
								WD	SA	ZZ
20	21	9	35	48	87	30°	172	5	56	180
25	21 (21.5)	9 (8.5)	40	48	87	30°	177	6.5	56	185
32	23	9	40	50	91	30°	183	5	58	191
40	25	9	50	56	100	20°	208	5	65	217
50	29	13	58	63	118	20°	241	9	75	253
63	28	12	58	64	117	20°	241	8	76	253

* () : With air cushion

Note) When the stroke A is a long stroke (ø20: 201 mm or more, ø25 to ø63: 301 mm or more)

Construction/Dimensions

MB series

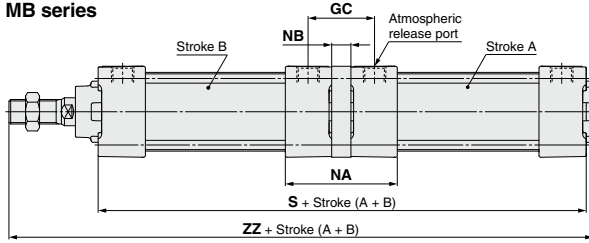

(mm)					
Bore size	GC	NA	NB	S	ZZ
32	36	64	10.6	179	230
40	38	64	10.6	179	234
50	41	73	10.6	199	261
63	43	73	10.6	199	261
80	52	90	14.6	243	319
100	52	90	14.6	243	319

MB1 series

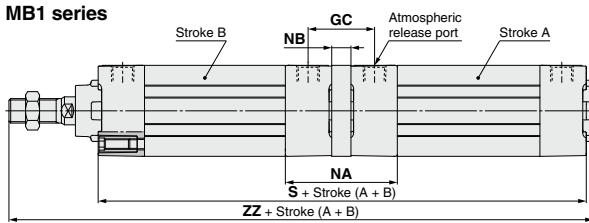

(mm)					
Bore size	GC	NA	NB	S	ZZ
32	36	62	10.6	179	230
40	38	62	10.6	179	234
50	41	71	10.6	199	261
63	43	71	10.6	199	261
80	52	88	14.6	243	319
100	52	88	14.6	243	319

CA2 series

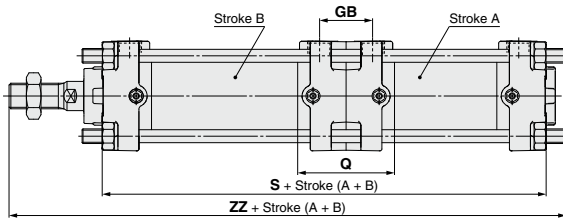

(mm)				
Bore size	GB	Q	S	ZZ
40	29	53	168	230
50	33	59	180	249
63	33	61	196	268
80	41	73	232	320
100	41	79	252	341

CNA2 series

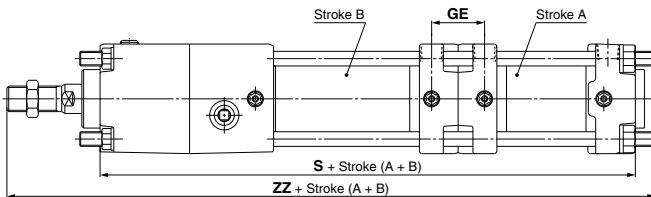

(mm)			
Bore size	GE	S	ZZ
40	29	237	299
50	33	258	327
63	33	280	352
80	41	334	422
100	41	372	461

Made to Order Common Specifications: -XC11: Dual Stroke Cylinder/Single Rod Type



23 Dual Stroke Cylinder/Single Rod Type

Construction/Dimensions

CS1 series

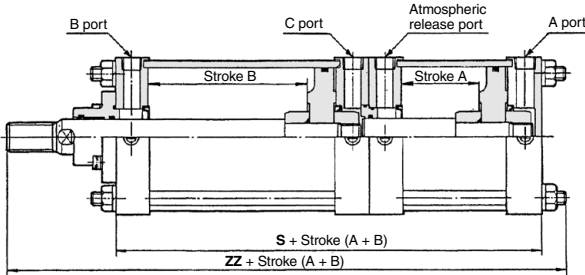

Bore size (mm)	(mm)			
	Without auto switch		With auto switch	
	S	ZZ	S	ZZ
125	197	334	197	334
140	197	334	197	334
160	213	363.5	213	363.5
180	223	393	231	401
200	223	393	241	411
250	283	484.5	—	—
300	293	519.5	—	—

CS2 series

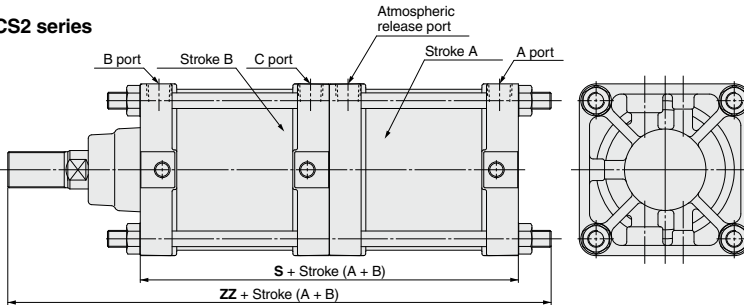

Bore size (mm)	(mm)	
	S	ZZ
125	197	334
140	197	334
160	213	363.5

CQS series

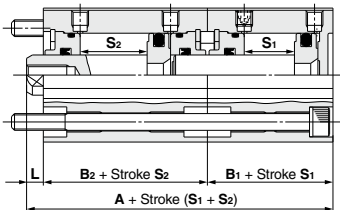

Bore size (mm)	(mm)				
	A	B ₁	B ₂	L	Stroke Both of S ₁ , S ₂
12	42.5 (52.5)	17 (22)	22 (27)	3.5	5 to 30
16	42.5 (52.5)	17 (22)	22 (27)	3.5	5 to 30
20	50 (70)	19.5 (29.5)	26 (36)	4.5	5 to 50
25	56.5 (76.5)	22.5 (32.5)	29 (39)	5	5 to 50

Note 1) (): Denotes the dimensions with auto switch.

Note 2) Applicable stroke available in 5 mm increments.

Note 3) Please contact SMC for long stroke type.

Made to Order Common Specifications:
Dual Stroke Cylinder/Sing Rod Type

Symbol
-XC11

CQ2 series

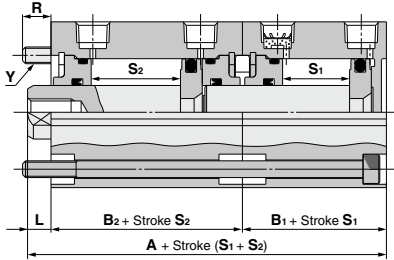

Bore size (mm)	A	B ₁	B ₂	L	R	Y	(mm)	
							Stroke Both S₁ and S₂	
12	45.7 (63.9)	17 (28)	25.2 (32.4)	3.5	8.3 (8.1)	M3 x 0.5	5 to 30	
16	48 (70)	18.5 (30.5)	26 (36)	3.5	9 (7)	M5 x 0.8	5 to 50	
20	50 (74)	19.5 (31.5)	26 (38)	4.5	11.5 (7.5)			
25	56.5 (76.5)	22.5 (32.5)	29 (39)	5	10.5	M6 x 1	10 to 50	
32	60.5 (80.5)	23 (33)	30.5 (40.5)	7	8.5			
40	76.5 (96.5)	29.5 (39.5)	40 (50)	7	7.5	M8 x 1.25	10 to 50	
50	79 (99)	30.5 (40.5)	40.5 (50.5)	8	12			
63	86 (106)	36 (46)	42 (52)	8	12.5	M10 x 1.5	10 to 50	
80	104.5 (124.5)	43.5 (53.5)	51 (61)	10	19			
100	125.5 (145.5)	53 (63)	60.5 (70.5)	12	15			

- * (): Dimensions with auto switch magnet
- * Applicable stroke available in 5 mm increments
- * Please contact SMC for long stroke type.

Precautions

⚠ Caution

1. Remove the temporary fixing nut and flat washer from the mounting bolt, and secure the cylinder properly with the mounting bolt.
2. Although the cylinder can be detached by removing the nut, do not detach it for purposes other than replacing the seal.
3. The removed nut and flat washer are not used to secure the body.

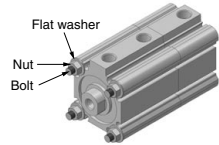

Made to Order Common Specifications: -XC11: Dual Stroke Cylinder/Single Rod Type



23 Dual Stroke Cylinder/Single Rod Type

MGG series

How to Order

MGG Bearing type Mounting type Bore size - Stroke A + Stroke B-A - Auto switch - XC11
Dual stroke cylinder/Single rod type ↓

Specifications

Bore size	20	25	32	40	50	63
Basic cylinder	$\phi 20$ to $\phi 50$: CDG1ZN <input type="text"/> Bore size - <input type="text"/> Stroke A + <input type="text"/> Stroke B-A Z - <input type="text"/> Auto switch - X428 $\phi 63$: CDG1ZN <input type="text"/> Bore size - <input type="text"/> Stroke A + <input type="text"/> Stroke B-A Z - <input type="text"/> Auto switch - XC11					
Dimensions	Refer to the table below.					
Piston speed	The piston speed for the stroke B retraction side is 50 to 500 mm/s.					
Specifications other than above	Same as standard type					

Dimensions (Dimensions other than below are the same as standard type.)

MGG series
 $\phi 20$ to $\phi 50$

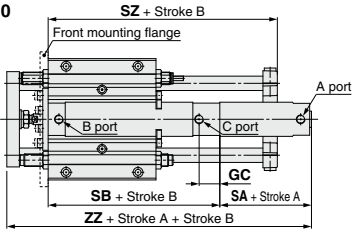

MGG Series

Bore size (mm)	GC	SA	SB	SZ	ZZ	Bracket mounting stroke (Stroke A + Stroke B)	Long stroke ^{Note}	
							SA	ZZ
20	21	50	87	118	176	35 st or more	58	184
25	21	50	87	129	183	60 st or more	58	191
32	23	52	91	155	189	80 st or more	60	197
40	25	58	100	182	214	125 st or more	67	223
50	29	65	118	218	250	160 st or more	77	262
63	28	66	132	254	252	210 st or more	78	264

Note) When the stroke A is a long stroke ($\phi 20$: 201 mm or more, $\phi 25$ to $\phi 63$: 301 mm or more)

$\phi 63$

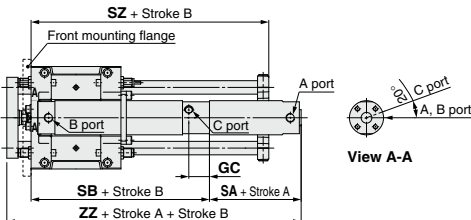

Made to Order Common Specifications: Dual Stroke Cylinder/Single Rod Type

Symbol
-XC11

MGC series

How to Order

MGC Bearing type Mounting type Bore size - Stroke A + Stroke B-A - Equipped/Not equipped back plate - Auto switch - **XC11**
Dual stroke cylinder/Single rod type

Specifications

Bore size	20	25	32	40	50
Basic cylinder	CDG1ZA Bore size - Stroke A + Stroke B-A Z - Auto switch - XC11				
Dimensions	Refer to the table below.				
Piston speed	The piston speed for the stroke B retraction side is 50 to 500 mm/s.				
Specifications other than above	Same as standard type				

Dimensions (Dimensions other than below are the same as standard type.)

MGC series ø20 to ø50

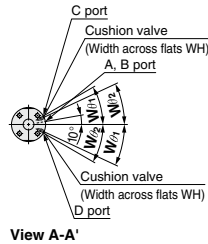
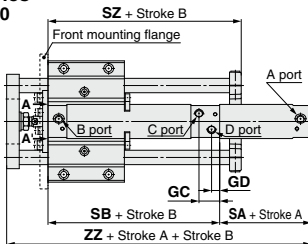

MGC Series

Bore size (mm)	GC	GD	SA	SB	W _{1/2}	W _{2/2}	Long stroke ^{Note)}	
							SA	ZZ
20	21	9	50	87	25°	30°	58	184
25	21.5	8.5	50	87	25°	30°	58	191
32	23	9	52	91	25°	30°	60	197
40	25	9	58	100	20°	20°	67	223
50	29	13	65	118	20°	20°	77	262

Bore size (mm)	SZ		ZZ	Bracket mounting stroke (Stroke A + Stroke B)
	With R	Without R		
20	101	80	176	35 st or more
25	107	85	183	60 st or more
32	115	90	189	80 st or more
40	132	100	214	125 st or more
50	174	135	250	160 st or more

Note) When the stroke A is a long stroke (ø20: 201 mm or more, ø25 to ø50: 301 mm or more)

