

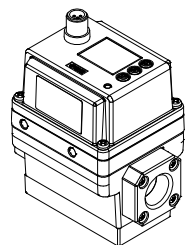

ORIGINAL INSTRUCTIONS

Instruction Manual
Flow Controller for Air
IN502-44-# / IN502-45-# series



The intended use of the flow controller is to monitor and display flow information with the optional connection to IO-Link communication.

1 Safety Instructions

- These safety instructions are intended to prevent hazardous situations and/or equipment damage. These instructions indicate the level of potential hazard with the labels of "Caution," "Warning" or "Danger." They are all important notes for safety and must be followed in addition to International Standards (ISO/IEC)⁽¹⁾, and other safety regulations.
- ⁽¹⁾ ISO 4414: Pneumatic fluid power - General rules relating to systems.
 - ISO 4413: Hydraulic fluid power - General rules relating to systems.
 - IEC 60204-1: Safety of machinery - Electrical equipment of machines. (Part 1: General requirements)
 - ISO 10218-1: Manipulating industrial robots -Safety, etc.
- Refer to product catalogue, Operation Manual and Handling Precautions for SMC Products for additional information.
 - Keep this manual in a safe place for future reference.

Caution	Caution indicates a hazard with a low level of risk which, if not avoided, could result in minor or moderate injury.
Warning	Warning indicates a hazard with a medium level of risk which, if not avoided, could result in death or serious injury.
Danger	Danger indicates a hazard with a high level of risk which, if not avoided, will result in death or serious injury.

Warning

- Always ensure compliance with relevant safety laws and standards.**
- All work must be carried out in a safe manner by a qualified person in compliance with applicable national regulations.
- This product is class A equipment intended for use in an industrial environment. There may be potential difficulties in ensuring electromagnetic compatibility in other environments due to conducted or radiated disturbances.
- Refer to the operation manual on the SMC website (URL: <https://www.smcworld.com>) for more Safety instructions.
- Special products (-X) might have specifications different from those shown in the specifications section. Contact SMC for specific drawings.

1 Safety Instructions (continued)

Caution

- When selecting equipment, carefully consider the application, required specifications, and operating conditions (fluid, pressure, flow rate, filtration, and environment), making sure not to exceed the specification range.
- This product is provided for normally typical forms of use in the manufacturing industry. As such, to use the product for applications that may affect the human body directly or indirectly such as caisson shield is not foreseen.
- When the product is used as an air blower for food, install an appropriate filter to eliminate foreign matter in compressed air for air blowing. (Refer to the following example of pneumatic circuit.)

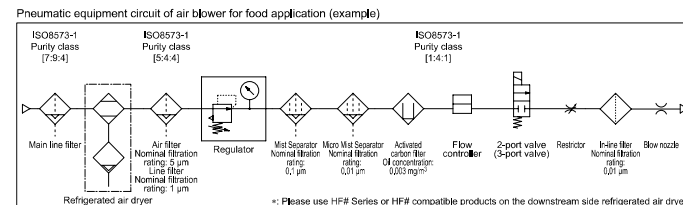

- Quality management relating to hygiene for food and medical treatment is not implemented for the product. The product is produced in same line that manufactures other product which uses other materials. In rare cases, some of these materials can be found as a residue.
- Food grease used
 - Fluid contact parts: NSF H1 grade grease
 - Part other than fluid contact parts: NSF H1 grade grease or grease which is not NSF H1 grade
- The grease used in the solenoid valves built into the product is not food grease. Grease may drain out of the product from the solenoid valve EXH. If necessary, pipe it to the outside of the area.

- The product generates particles from the wear of sliding parts inside. When the product is used as an air blower, install an appropriate filter on the outlet of the product to prevent foreign matter from flowing to the downstream. Filters require regular inspection, replacement of the element, and maintenance referring to the operation manual.
- Flush the piping line before using the product for the first time and after it has been replaced. Also, if piping, etc., is to be connected, flush (air blow) before using the product for the first time in order to reduce the effects of the dust generated from the connection, etc. Flushing the line is also required to eliminate contamination resulting from the installation of piping lines. Therefore, be sure to flush the line before running the system.

2 Specification

Model	IN502-44	IN502-45	
Fluid	Applicable fluids	Air, Nitrogen	
	Fluid temperature range	0 to 50 °C	
Flow	Rated controlled flow range	50 to 500 L/min 100 to 1000 L/min	
	Set controlled flow rate range	25 to 525 L/min 50 to 1050 L/min	
	Minimum unit of set controlled flow rate	1 L/min 1 L/min	
	Pressure		
Operating range	Supply pressure	1.0 MPa or less	
	Load pressure	0.1 to 0.6 MPa (when the flow rate is 100% F.S)	
Withstand pressure	1.0 MPa		
Electrical	Power supply voltage	24 VDC ±10%	
	Current consumption	0.2 A or less	
	Protection	Polarity protection	
Control	Control accuracy	±5% F.S.	
	Temperature characteristics	±5% F.S. (0 to 50 °C, 25 °C standard)	
	Pressure characteristics	±5% F.S. (operating pressure range, standard pressure standard)	
	Settling time	Reaches the range of ±5% F.S. of the commanded flow rate in 0.5 s or less (at standard pressure)	
Analogue output	Voltage	Output type	Voltage output: Select from 1 to 5 V or 0 to 10 V
		Output impedance	Approx. 1 kΩ
	Current	Output type	Current output: 4 to 20 mA
		Load impedance	Approx. 50 to 600 Ω
Analogue input (in SIO mode)	Voltage	Input type	Voltage input: Select from 0 to 5 V or 0 to 10 V
		Input impedance	Approx. 1 MΩ
	Current	Input type	Current input: 4 to 20 mA
		Input impedance	Approx. 50 Ω
Switch output (in SIO mode)	Output type	Select from NPN or PNP open collector output	
	Output mode	Limit deviation tolerance, error output, output OFF	
	Switch operation	Normal output, reverse output	
	Maximum load current	80 mA	
	Max applied voltage (NPN only)	30 VDC	
	Internal volt drop (Residual voltage)	1.5 V or less (at 80 mA load current)	
	Delay time	5 ms or less, variable from 0 to 60 s/0.01 s increments	
Protection	Over current protection		
Display	Flow rate	Reference condition	Select standard or reference condition
		Unit	L/min, cfm (ft ³ /min)
		Display range	25 to 525 L/min 50 to 1050 L/min
	Minimum unit	1 L/min	
	Pressure	Units	kPa, MPa, kgf/cm ² , bar, psi
		Display range	-50 to 1050 kPa
Minimum unit		1 kPa	
Display method	LCD		
Number of displays	3 (1 main display and 2 Sub displays)		
Display colour	Main display: red/green, Sub display: orange		
Displayed digits	Main display: 4-digit 7-segment Sub display (left): 4 digits (partially 11-segments, 7-segments for other) Sub display (right): 5 digits (partially 11-segments, 7-segments for other)		
Operation LED	Turns ON when switch output is ON (OUT1: Orange)		

2 Specifications (continued)

Models	IN502-44	IN502-45
Environmental	Enclosure protection	IP65
	Withstand voltage	1000 V AC for 1 minute between terminals and housing
	Insulation resistance	50 MΩ between terminals and housing (with 500 VDC megger)
	Operating temperature range	Operation: 0 to 50 °C, Storage: -10 to 60 °C (no condensation)
	Operating humidity range	Operation and storage: 35 to 85%RH (no condensation)
Piping specification	Rc1/2	
Material in contact with fluid	Aluminum alloy, POM, SUS304, steel, brass, Si, NBR, HNBR, FKM	
Weight	760 g approx. (excluding lead wire)	

2.1 IO-Link specifications (for models with IO-Link)

IO-Link type	Device
IO-Link version	V1.1
Communication speed	COM2 (38.4 kbps)
Min. cycle time	5.5 ms
Process data length	Input data: 8 bytes, Output data: 2 bytes
On request data communication	Available
Data storage function	Available
Event function	Available
Vendor ID	131 (0x0083)
Device ID	IN502-44-5/6/13/14: 575 (0x00023F) IN502-44-7/8/15/16: 576 (0x000240) IN502-45-5/6/13/14: 577 (0x000241) IN502-45-7/8/15/16: 578 (0x000242)
Configuration file	IODD file (download from the SMC website)

3 Name and function of parts

3.1 Body

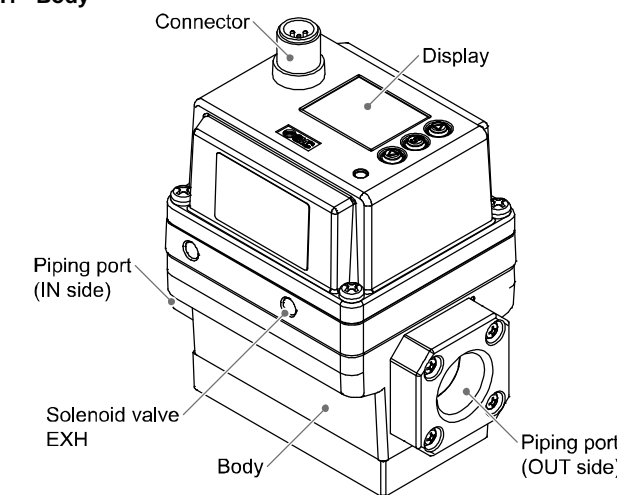

Part	Description
Connector	M12 connector for electrical connections.
Piping port	Port for connecting piping (Rc 1/2). IN represents "inlet" and OUT represents "outlet".
Body	Body of the product.
Solenoid valve EXH	Exhaust port (M5 female thread) for the internal solenoid valve. Do not block the exhaust.
Display	Displays the flow, settings and error codes (See below).

3 Name and function of parts (continued)

3.2 Display

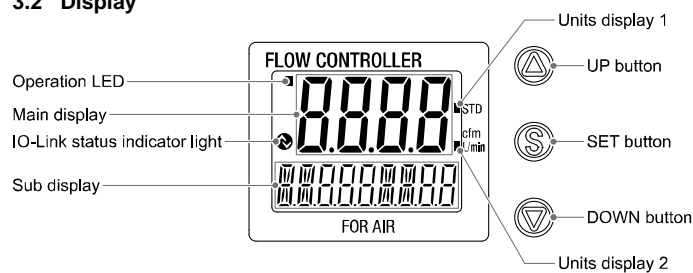

Part	Description
Operation LED	LED is ON (orange) when OUT is ON.
Main display (red/green)	Displays the current controlled flow, setting mode status, selected display units and error codes.
UP button	Selects the mode and increases the ON/OFF set value.
SET button	Press this button to change the mode and to confirm settings.
DOWN button	Changes the sub display, selects the mode and decreases the ON/OFF set value.
Units display 1 (red/green)	LED turns ON when STD is selected for the reference condition.
Units display 2 (red/green)	LED indicates the selected flow rate units.
Sub display (left)	Displays (orange) the display item label.
Sub display	Displays (orange) the display item, setting value, peak/bottom value, etc.
IO-Link status indicator light	Displays OUT1 output communication status (SIO mode, start-up mode, Pre-operation mode, operation mode) and presence of communication data (for products with IO-Link only).

- Refer to the operation manual on the SMC website (URL: <https://www.smcworld.com>) for more details of the IO-Link status indicator light operation and display.

4 Installation

4.1 Installation

Warning

- Do not install the product unless the safety instructions have been read and understood.
- Use the product within the specified operating pressure and temperature range.

4.2 Environment

Warning

- Do not use in an environment where corrosive gases, chemicals, salt water, water or steam are present.
- Do not use the product in an environment where the product is constantly exposed to water or oil splashes.
- Do not use in an explosive atmosphere.
- Do not expose to direct sunlight. Use a suitable protective cover.
- Do not install in a location subject to vibration or impact in excess of the product's specifications.
- Do not mount in a location exposed to radiant heat that would result in temperatures in excess of the product's specifications.
- Do not use in an area where electrical surges are generated.
- Prevent foreign matter such as remnant of wires from entering the product

4.3 Mounting

- Never mount the product in a location where it will be used as a foothold.
- Do not mount the product upside down.
- Mount the product so that the fluid flows in the direction indicated by the arrow on the side of the body.
- If the EXH port of the solenoid valve may be exposed to water or dust, connect a fitting and tube (sold separately) and route the tube to a safe place where it will not be affected by water or dust.

4 Installation (continued)

- Install the product using 4 screws suitable for the product, tightened according to the required tightening torque.
- Suitable screw: M5, Tightening torque: 3 N·m ±10%
- Screws should be prepared by the user.

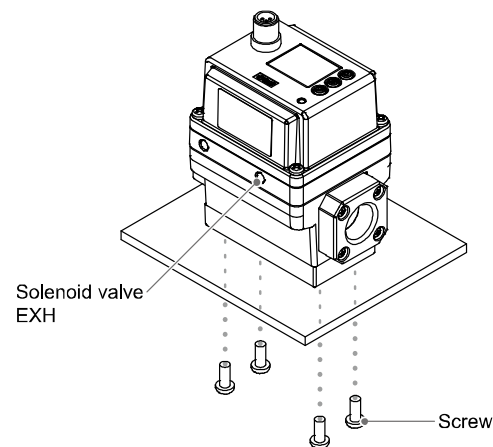

Refer to the operation manual on the SMC website (URL: <https://www.smcworld.com>) for mounting hole details and outline dimensions.

4.4 Piping

Caution

- Before connecting piping make sure to clean up chips, cutting oil, dust etc.
- When installing piping or fittings, ensure sealant material does not enter inside the port.
- Tighten the piping to the correct tightening torque: 20 to 25 N·m. If the tightening torque is exceeded, the product can be damaged. If the tightening torque is insufficient, the connection threads and brackets may become loose.

- Confirm that there is no leakage after piping.
- When attaching a fitting, the attachment should be held with a wrench. Holding other parts with a wrench may damage the product.

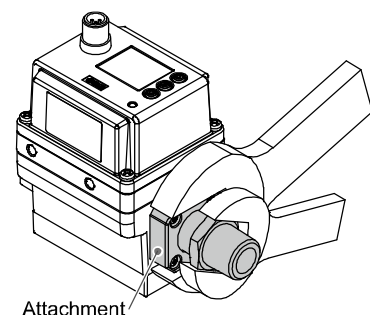

5 Wiring

5.1 Wiring

Caution

- Connections should only be made with the power supply turned off.
- Use a separate route for the product wiring. If wires and cables are routed together with power or high voltage cables, malfunction may result due to noise.
- If a commercially available switching power supply is used, be sure to ground the frame ground (FG) terminal. If a switch-mode power supply is connected for use, switching noise will be superimposed and the product will not be able to meet the specifications. In that case, insert a noise filter such as a line noise filter/ferrite between the switching power supply and the product, or change the switching power supply to a series power supply.

5 Wiring (continued)

5.2 Connector installation / removal

- Align the lead wire M12 connector with the connector key groove on the controller, and insert it straight in. Turn the knurled part clockwise. Connection is complete when the knurled part is fully tightened. Check that the connection is not loose.
- To unplug the connector, loosen the knurled part and pull it straight out.

Connector pin layout

When used as a Switch output device

No.	Name	Wire colour	Function
1	DC(+)	Brown	24 VDC
2	An IN	White	Analogue input
3	DC(-)	Blue	0 V
4	OUT	Black	Switch output
5	An OUT	Grey	Analogue output

When used as an IO-Link device

No.	Name	Wire colour	Function
1	L(+)	Brown	24 VDC
2	An IN	White	Analogue input
3	L(-)	Blue	0 V
4	C/Q	Black	IO-Link communication
5	N.C. / An OUT	Grey	N.C. or Analogue output.

6 Outline of Settings

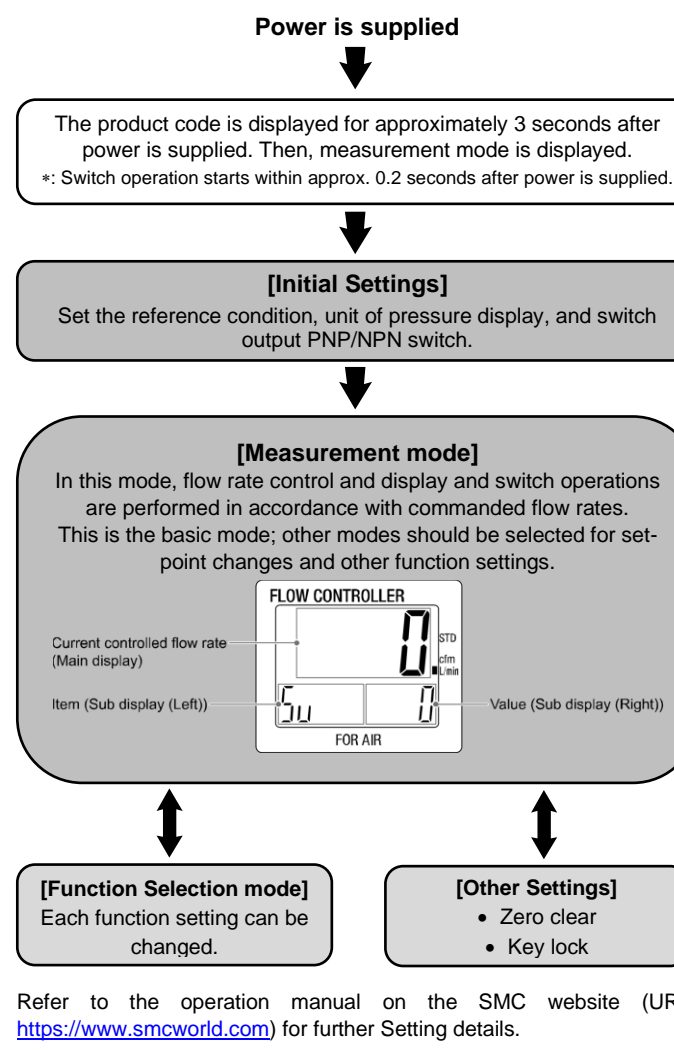

Refer to the operation manual on the SMC website (URL: <https://www.smcworld.com>) for further Setting details.

7 Initial Settings

- Configure the reference condition, unit of pressure display, and switch output PNP/NPN switch.
- Reference condition**: Standard condition or normal condition can be selected for the standard reference condition of flow rate. Standard condition: flow rate converted into volume at 20 °C and 101.3 kPa (absolute pressure). Normal condition: flow rate converted into volume at 0 °C and 101.3 kPa (absolute pressure).
- Units selection function**: The flow rate display units selection function allows for selecting L/min or cfm (ft³/min) as the standard unit. The pressure units selection function allows for selecting kPa, MPa, kgf/cm², bar, or psi as the standard unit. This setting is only available for models with the units selection function.
- Switch output type**: The switch output function can be toggled between PNP and NPN output.

8 Function Selection mode

In measurement mode, press the SET button for at least 1 second but no more than 3 seconds to display [F 0]. The mode in which [F□□] is displayed and changes to the respective function settings are made is referred to as function selection mode. Press the SET button for 2 seconds or longer in function selection mode to return to measurement mode. Note: Some functions are not supported on models with specific product numbers. [---] will be displayed on the sub display (right) for functions that are not supported or cannot be selected due to other settings.

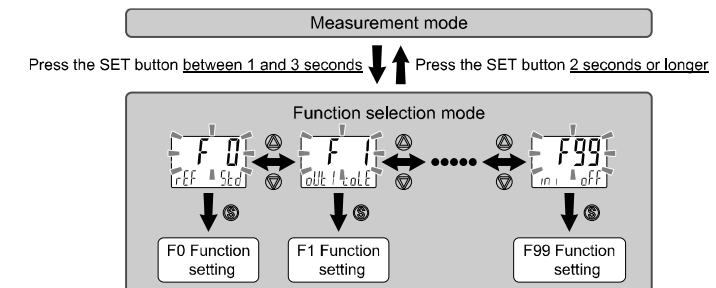

8.1 Default settings

- The factory default settings are as follows. If these settings are acceptable, retain for use. To change a setting, enter function selection mode.
- [F 0] Reference condition, unit of pressure display, and switch output PNP/NPN.

Item	Default setting
Reference condition	Standard condition
Flow rate display unit	L/min
Pressure display unit	kPa
Switch output PNP/NPN switch	PNP

[F 1] Setting of OUT1

Item	Description	Default setting
Output mode	Limit deviation tolerance mode, error output mode, or switch output off can be selected.	Limit deviation tolerance mode
Reverse output	Selects which switch output is used, Normal or Reverse.	Normal output
Limit deviation tolerance	Sets the switch output on or off when measured flow rate is within the limit deviation tolerance of set flow rate.	±2% F.S.
ON delay time	Delay time (rising) of switch output can be selected.	0.00 sec.
OFF delay time	Delay time of (falling) switch output can be selected.	0.00 sec.
Display colour	Select the display colour.	Output ON: Green Output OFF: Red

8 Function Selection mode (continued)

- Other Function Settings

Item	Default setting
[F10] Sub display setting	dEF (standard)
[F14] Zero cut-off setting	5.0% F.S.
[F21] Analogue input setting	Voltage input: 0 to 5 V Current input: No configurable items
[F22] Analogue output setting	Voltage output: 1 to 5 V Current output: No configurable items
[F32] Control parameter setting	0.000
[F33] Output process data setting in the event of abnormal communication	Output process data: 0
[F80] Power saving mode setting	OFF
[F81] Security code	OFF
[F90] Setting of all functions	OFF
[F96] Input check	No configurable items
[F98] Output check	N/A (normal output)
[F99] Reset to default settings	OFF

9 Other Settings

- Peak / Bottom value display
- Zero clear
- Key-lock function

Refer to the operation manual on the SMC website (URL: <https://www.smcworld.com>) for setting these functions.

10 IO-Link parameter setting

- IODD file**
IODD (I/O Device Description) is a definition file which provides all properties and parameters required for establishing functions and communication of the device.
IODD includes the main IODD file and a set of image files such as vendor logo, device picture and device icon.
The IODD file list is shown below.

Product No.	IODD file *1
IN502-44-5/6/13/14	SMC-IN502-44-5_6_13_14-yyyyymmdd-IODD1.1
IN502-44-7/8/15/16	SMC-IN502-44-7_8_15_16-yyyyymmdd-IODD1.1
IN502-45-5/6/13/14	SMC-IN502-45-5_6_13_14-yyyyymmdd-IODD1.1
IN502-45-7/8/15/16	SMC-IN502-45-7_8_15_16-yyyyymmdd-IODD1.1

*1: "yyyyymmdd" indicates the file preparation date. yyyy is the year, mm is the month and dd is the date.

- The latest IODD file can be downloaded from the SMC website (<https://www.smcworld.com>).

11 How to Order





Refer to the SMC website (URL: <https://www.smcworld.com>) for more How to Order details.

12 Outline Dimensions (mm)

Refer to the SMC website (URL: <https://www.smcworld.com>) for details of Outline dimensions.

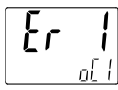
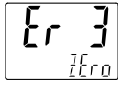
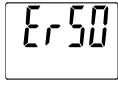
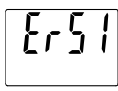
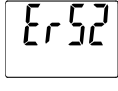
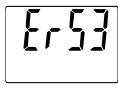
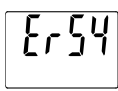
13 Troubleshooting

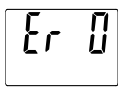
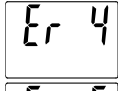
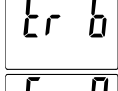
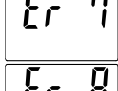
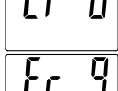
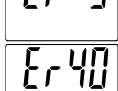
13.1 Error indication

Error name	Error display	Description	Measures
Over current error		The switch output load current is 80 mA or more.	Turn the power off and remove the cause of the over current. Then supply the power again.
Residual pressure error		During a zero-clear operation, pressure greater than ± 50 kPa is applied. The zero-clear range varies by ± 10 kPa due to variation between individual products.	Adjust the applied pressure to atmospheric pressure and retry the zero-clear operation.
Controlled flow rate not reached		The controlled flow rate has not reached the set flow rate.	(1) Refer to the operation manual to use the product within the controllable flow rate range. (2) Review the installation space environment, including the piping diameter.
Connected load error		The operating pressure range has been exceeded due to connected load.	Check that the load pressure is within the operating pressure range.
Control error	  	(1) The internal solenoid valve or sensor is not operating normally. (2) The product is possibly mounted in the opposite orientation (IN-OUT).	(1) Check that the power supply voltage is 24 VDC $\pm 10\%$. Turn the power off, then on again, then perform a zero-clear operation. (2) Mount the product in the correct orientation.
Excess flow rate error		The flow rate has exceeded the upper limit of the displayable flow range.	The flow display will resume when the flow rate is within the displayable flow range.
System error	      	Displayed if an internal data error has occurred.	Turn the power off and on again.

If the error cannot be reset after the above measures are taken, or errors other than the above are displayed, please contact SMC.

14 Maintenance

14.1 General Maintenance

Caution

- Not following proper maintenance procedures could cause the product to malfunction and lead to equipment damage.
- If handled improperly, compressed air can be dangerous.
- Maintenance of pneumatic systems should be performed only by qualified personnel.
- Before performing maintenance, turn off the power supply and be sure to cut off the supply pressure. Confirm that the air is released to atmosphere.
- After installation and maintenance, apply operating pressure and power to the equipment and perform appropriate functional and leakage tests to make sure the equipment is installed correctly.
- If any electrical connections are disturbed during maintenance, ensure they are reconnected correctly and safety checks are carried out as required to ensure continued compliance with applicable national regulations.
- Do not make any modification to the product.
- Do not disassemble the product, unless required by installation or maintenance instructions.

How to reset the product after a power cut or when the power has been unexpectedly removed

The settings for the product are retained in memory prior to the power loss or de-energizing of the product.
The output condition is also recoverable to that prior to the power loss or de-energizing. However, this may change depending on the operating environment. Therefore, check the safety of the whole installation before operating the product.
If the installation is using accurate control, wait until the product has warmed up (approximately 10 to 15 minutes) before operation.

15 Limitations of Use

15.1 Limited warranty and Disclaimer/Compliance Requirements

Refer to Handling Precautions for SMC Products.

16 Product disposal

This product should not be disposed of as municipal waste. Check your local regulations and guidelines to dispose of this product correctly, in order to reduce the impact on human health and the environment.

17 Contacts

Refer to www.smcworld.com or www.smc.eu for your local distributor / importer.

SMC Corporation

URL: <https://www.smcworld.com> (Global) <https://www.smc.eu> (Europe)
SMC Corporation, 4-14-1, Sotokanda, Chiyoda-ku, Tokyo 101-0021, Japan
Specifications are subject to change without prior notice from the manufacturer.
© 2022-2023 SMC Corporation All Rights Reserved.
Template DKP50047-F-085M